

CURRENT 60 Ampere
 VOLTAGE RANG 600 Volts

APT60DQ60BG

Product Applicationg:

- Switch mode Power Supply
- Inverters
- Free Wheeling Diode
- Motor Controllers
- Converters
- Inverters
- Snubber Diode
- PFC

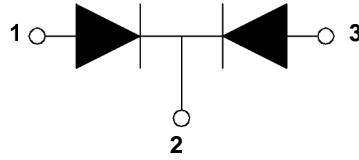

1 - Anode
 3 - Anode
 2 - Cathode

Package:

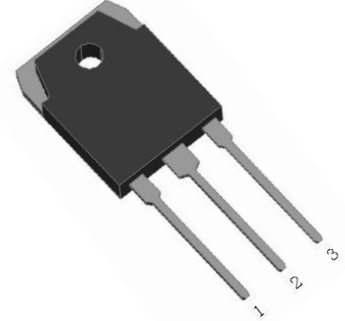

Product Features:

- Ultrafast Recovery Times
- Soft Recovery Characteristics
- Popular TO-3P Package
- Low Forward Voltage
- Low Leakage Current
- Avalanche Energy Rated

Circuit diagram

MAXIMUM RATINGS

All Ratings: Tc = 25° C unless otherwise specified.

Symbol	Characteristic / Test Conditions	TYP	UNIT
VR	Maximum D.C. Reverse Voltage	600	Volts
VRRM	Maximum Peak Repetitive Reverse Voltage		
IF(AV)	Maximum Average Forward Current (Tc = 100°C, Duty Cycle = 0.5)	60 (30*2)	Amps
IFSM	Non-Repetitive Forward Surge Current (TJ = 25°C, 8.3ms)	400	
TJ , TSTG	Operating and Storage Temperature Range	-55 to 150	° C
TL	Lead Temperature for 10 Sec	260	

CURRENT 60 Ampere
 VOLTAGE RANG 600 Volts

APT60DQ60BG

STATIC ELECTRICAL CHARACTERISTICS

Symbol	Characteristic / Test Conditions	TYP	MAX	UNIT	
VF	Forward Voltage	IF = 30A, Tj = 25°C	2.0	2.4	Volts
		IF = 30A, Tj = 150°C	1.4	1.8	
IRM	Maximum Reverse Leakage Current	VR = 600V, Tj =25°C		10	μ A
		VR = 600V, Tj =150°C		500	
Trr	Reverse Recovery Time	IF=0.5A IRM=1A IRR=0.25A TC=25°C	35	45	ns
CJ	Junction Capacitance, VR =200V		25		pF

THERMAL AND MECHANICAL CHARACTERISTICS

Symbol	Characteristic / Test Conditions	S2FD60B60 B	UNIT
Rθ JC	Junction-to-Case Thermal Resistance	1.0	°C/W
WT	Package Weight	5.4	g
Torque	Maximum Mounting Torque	0.5	N. m

CURRENT 60 Ampere
 VOLTAGE RANG 600 Volts

APT60DQ60BG

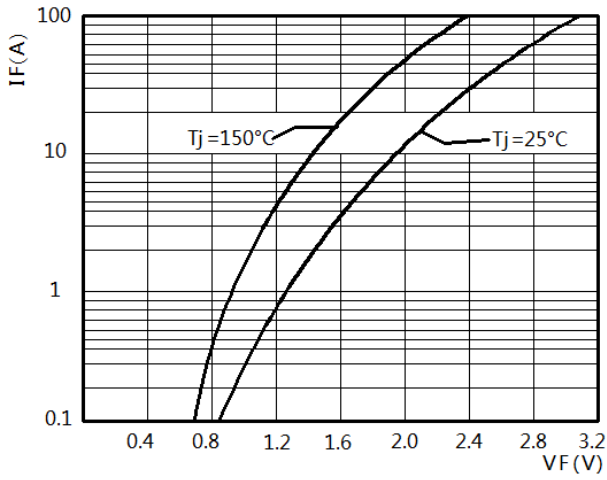

FIGURE 1. FORWARD CURRENT vs FORWARD VOLTAGE

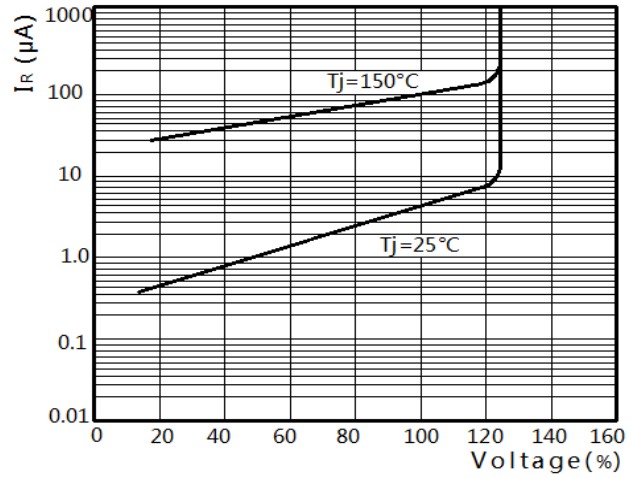

FIGURE 2. REVERSE CURRENT vs REVERSE VOLTAGE

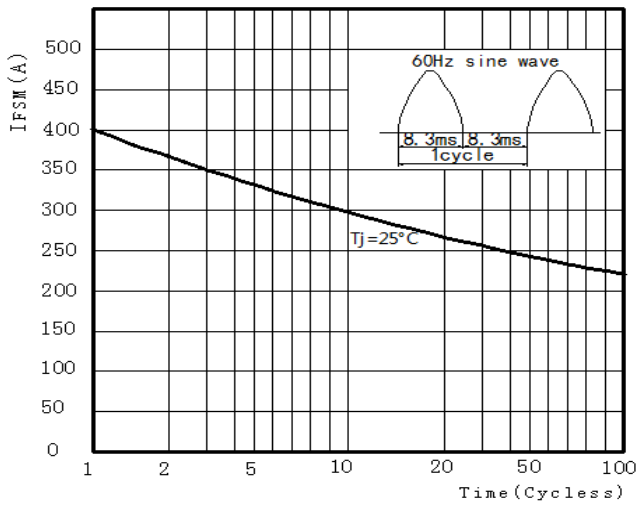

FIGURE 3. Peak Surge Forward Capability

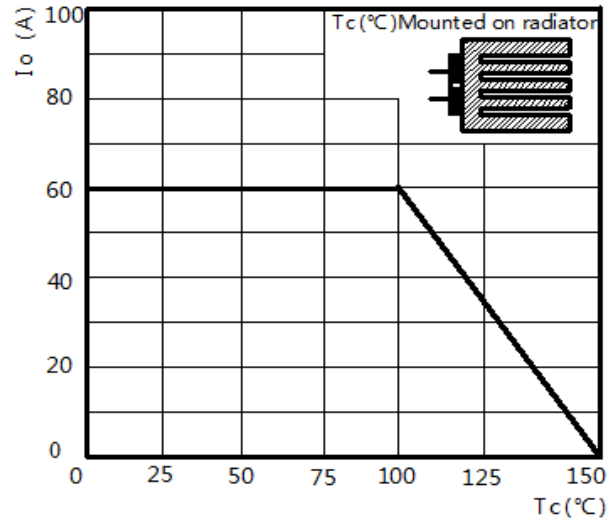

FIGURE 4. CURRENT DERATING CURVE

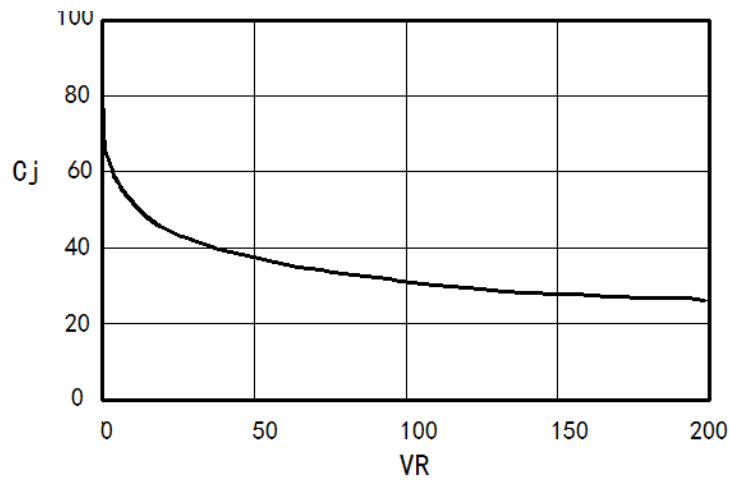
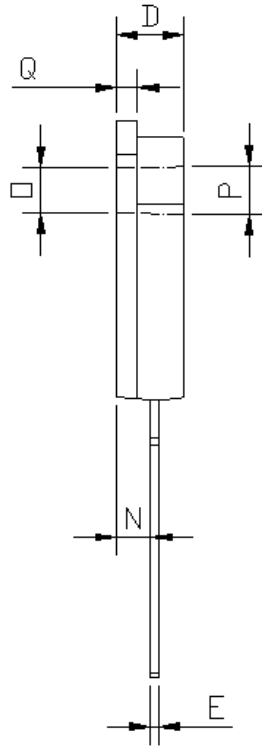
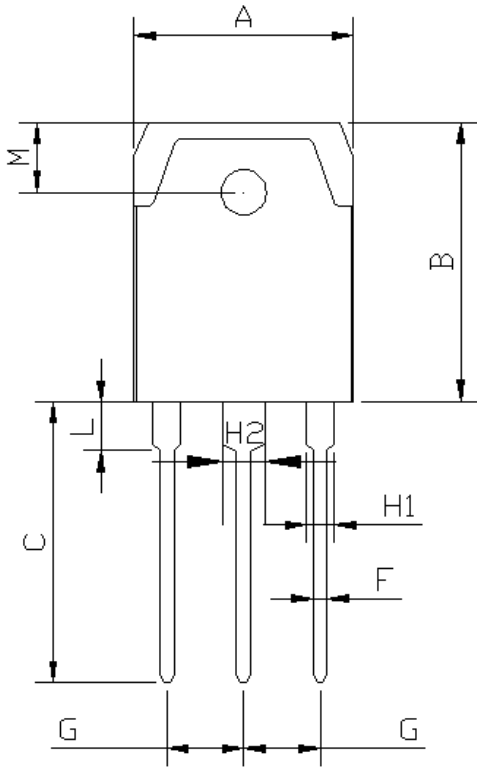

FIGURE 5. JUNCTION CAPACITANCE vs REVERSE VOLTAGE

CURRENT 60 Ampere
 VOLTAGE RANG 600 Volts

APT60DQ60BG



Dim.	Millimeter		Inches	
	min	max	min	max
A	15.1	16.1	0.594	0.634
B	19.4	20.4	0.764	0.803
C	19	20	0.748	0.787
D	4.3	5.3	0.169	0.209
E	0.4	0.8	0.016	0.031
F	0.8	1.2	0.031	0.047
G	5.25	5.65	0.207	0.222
H1	1.8	2.2	0.071	0.087
H2	2.8	3.2	0.110	0.126
L	2.7	3.1	0.106	0.122
M	4.7	5.3	0.185	0.209
N	2.2	2.6	0.087	0.102
O	3	3.3	0.118	0.130
P	3.3	3.6	0.130	0.142